

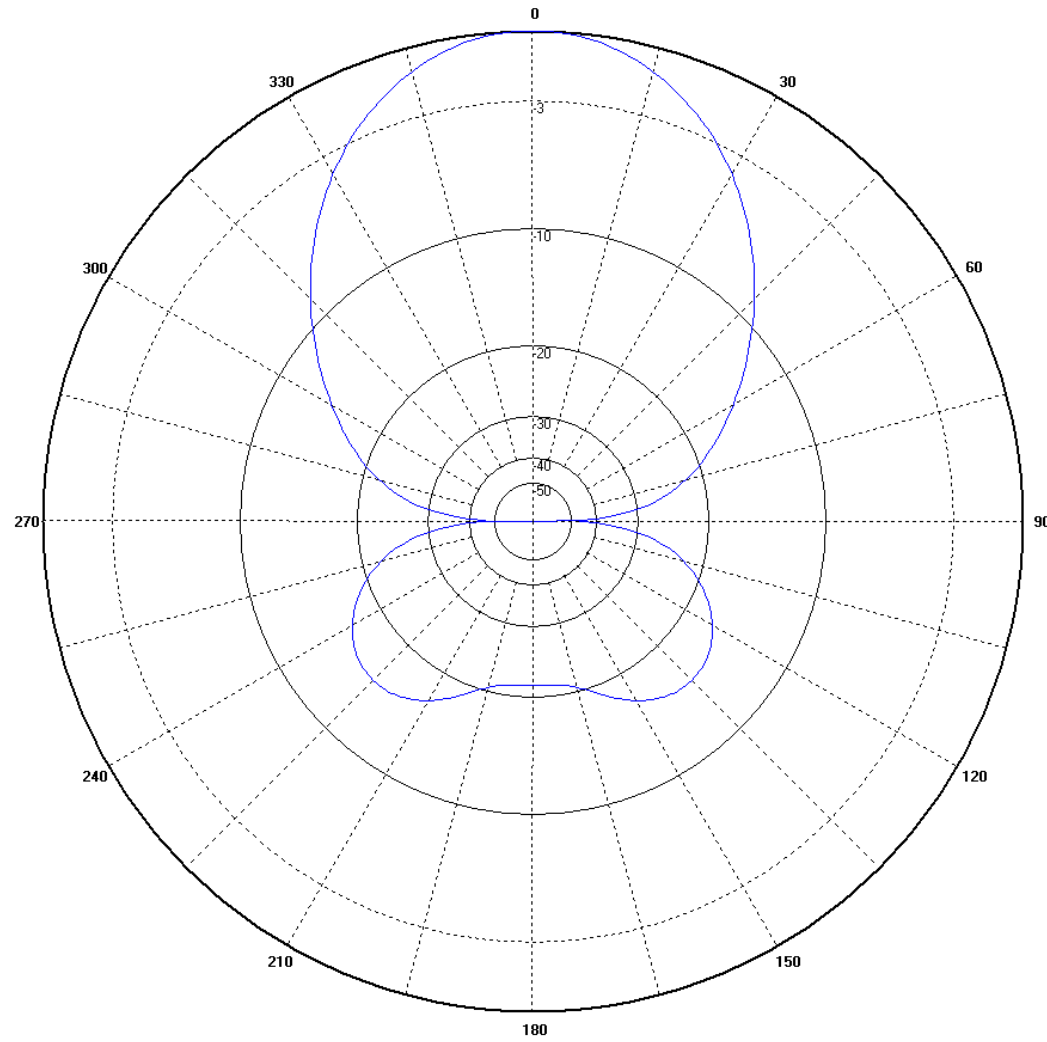

P204.N4W Azimuth Total Field

Frequency = 550.000 MHz
Antenna in Free Space
Z1 = 848.58 - j 286.68 (3.19)
Zenith Angle = 0 deg.
Max = 12.77 dBi
F/B = 21.29 dB
Lobe at : 0° (BW:52°)
Lobe at : 135°
Lobe at : 225°

0 dB = 12.77 dBi





3D View & Currents - D:\Roger\Nec Models\Nec4Win\VM\Television\uhf\Paineis\VP204\VP204.n4w

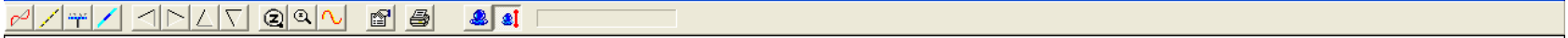

Show Pulses
P204.n4w

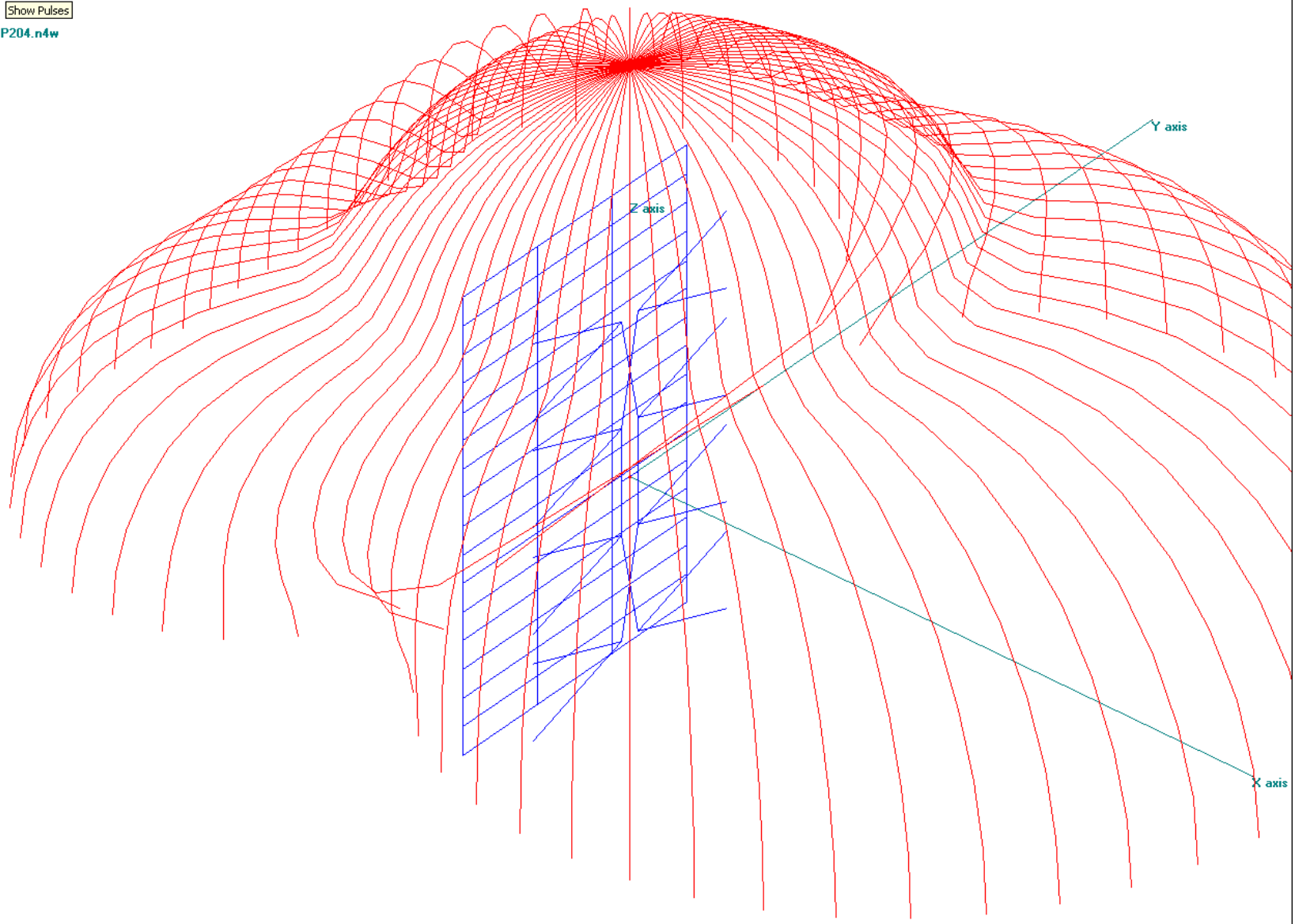



DISA

3D View & Currents - D:\Roger\Nec Models\Nec4Win\VM\Television\uhf\Paints\VP 204\VP 204.n4w

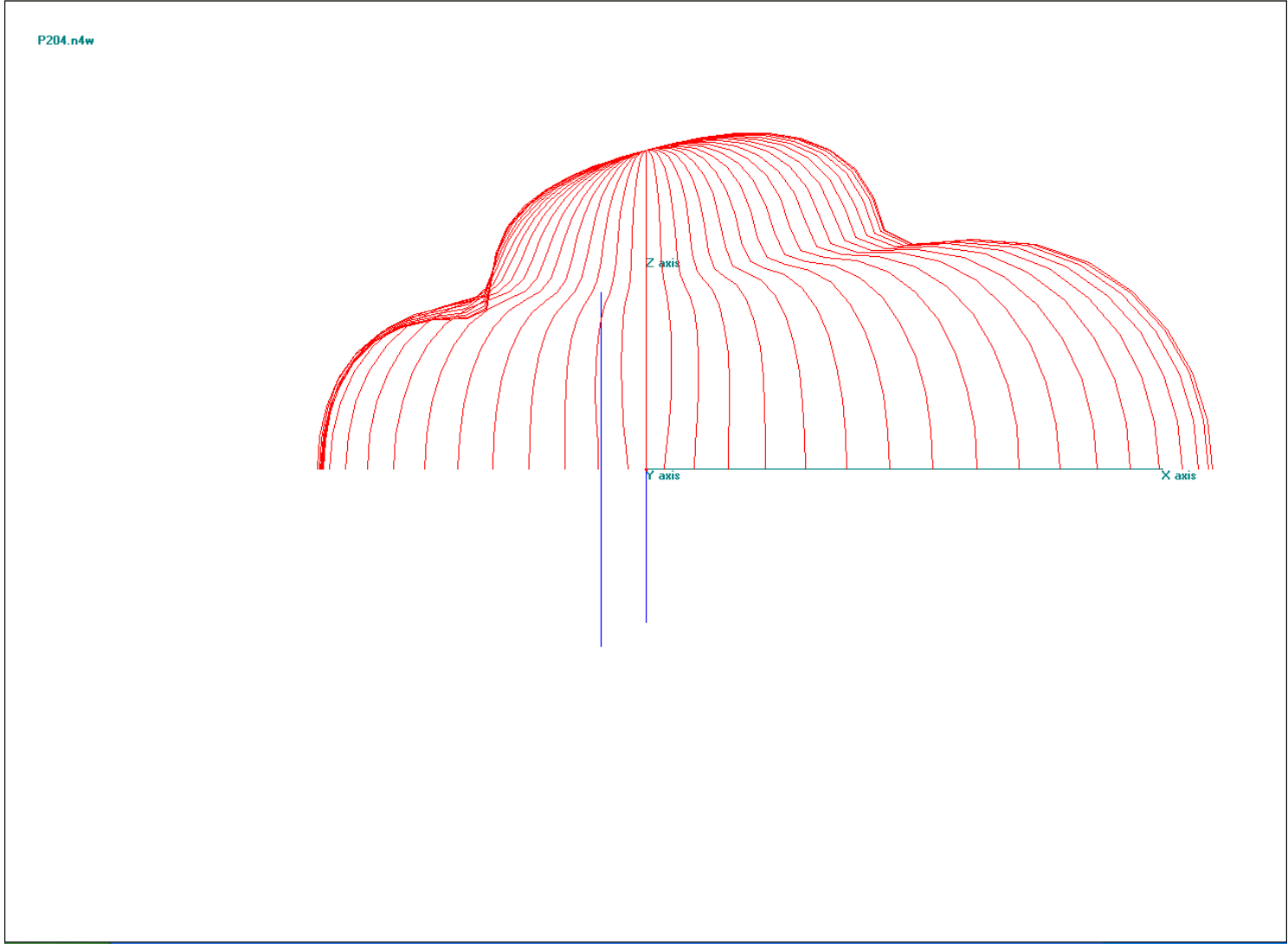



DISA

3D View & Currents - D:\Roger\Nec Models\Nec4Win\VM\Television\uhf\Paintis\VP 204\VP 204.n4w

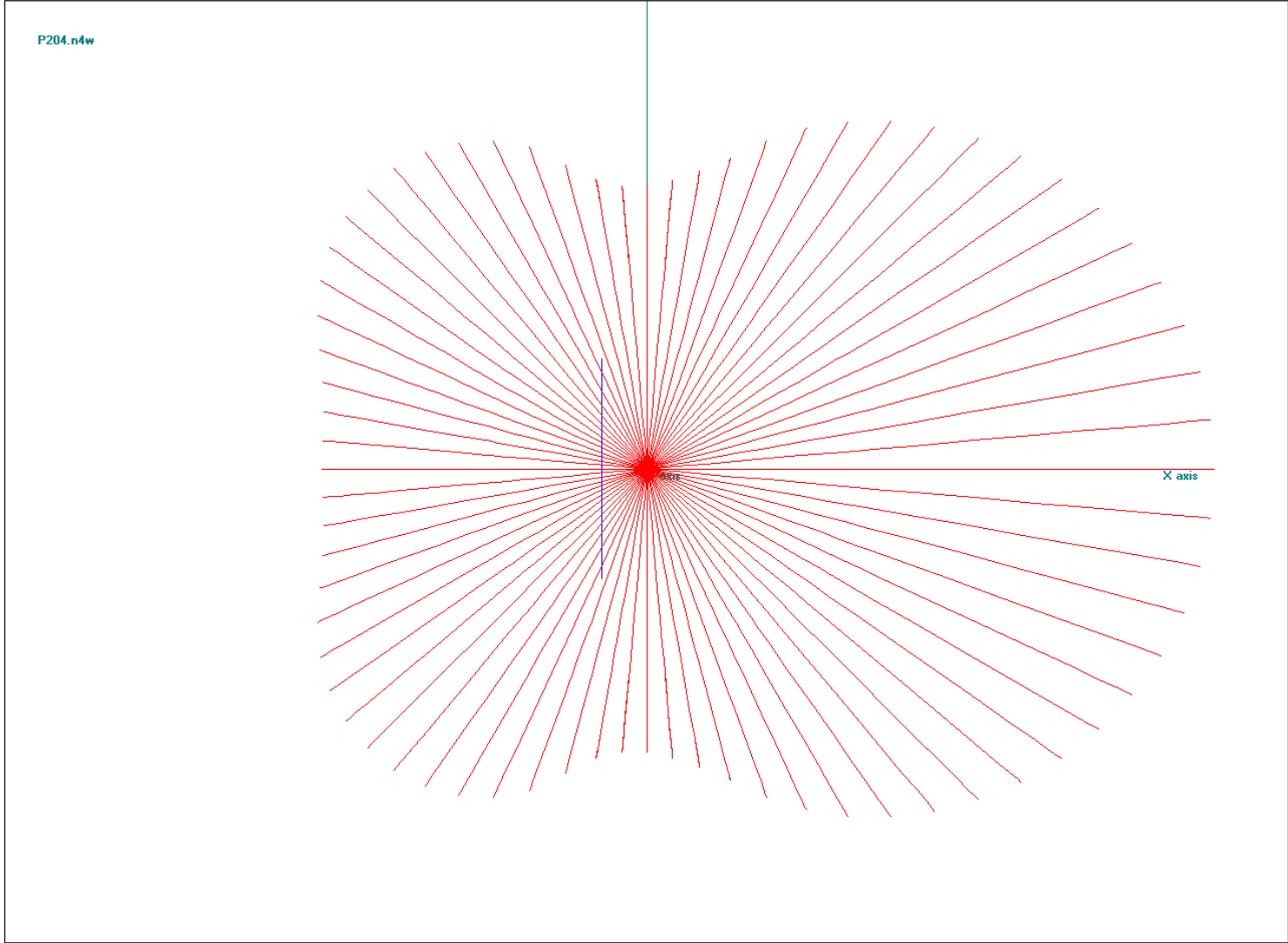

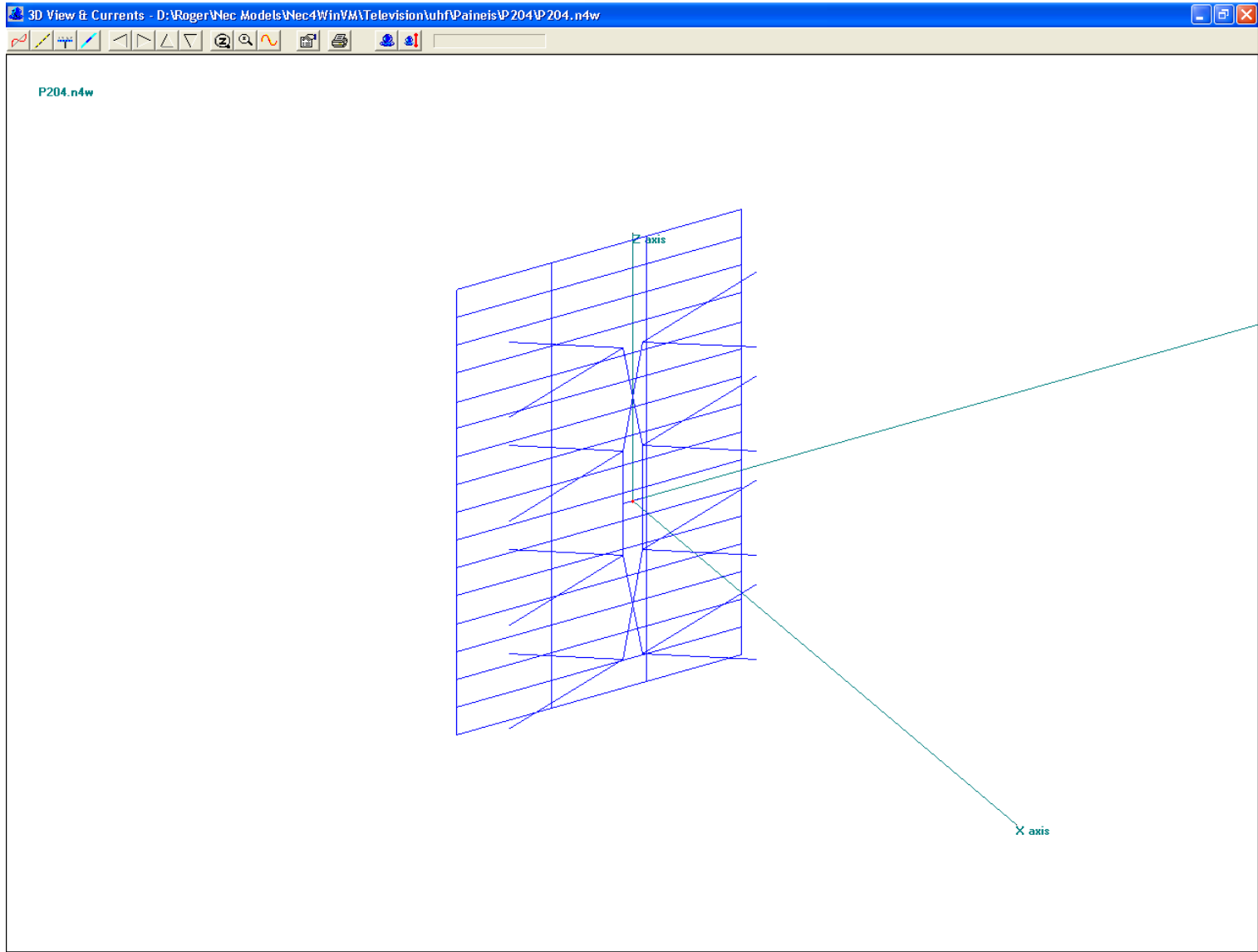



DISA

Antenna Gain [min] [max] [close]

F = 806.000 Gain = 13.91

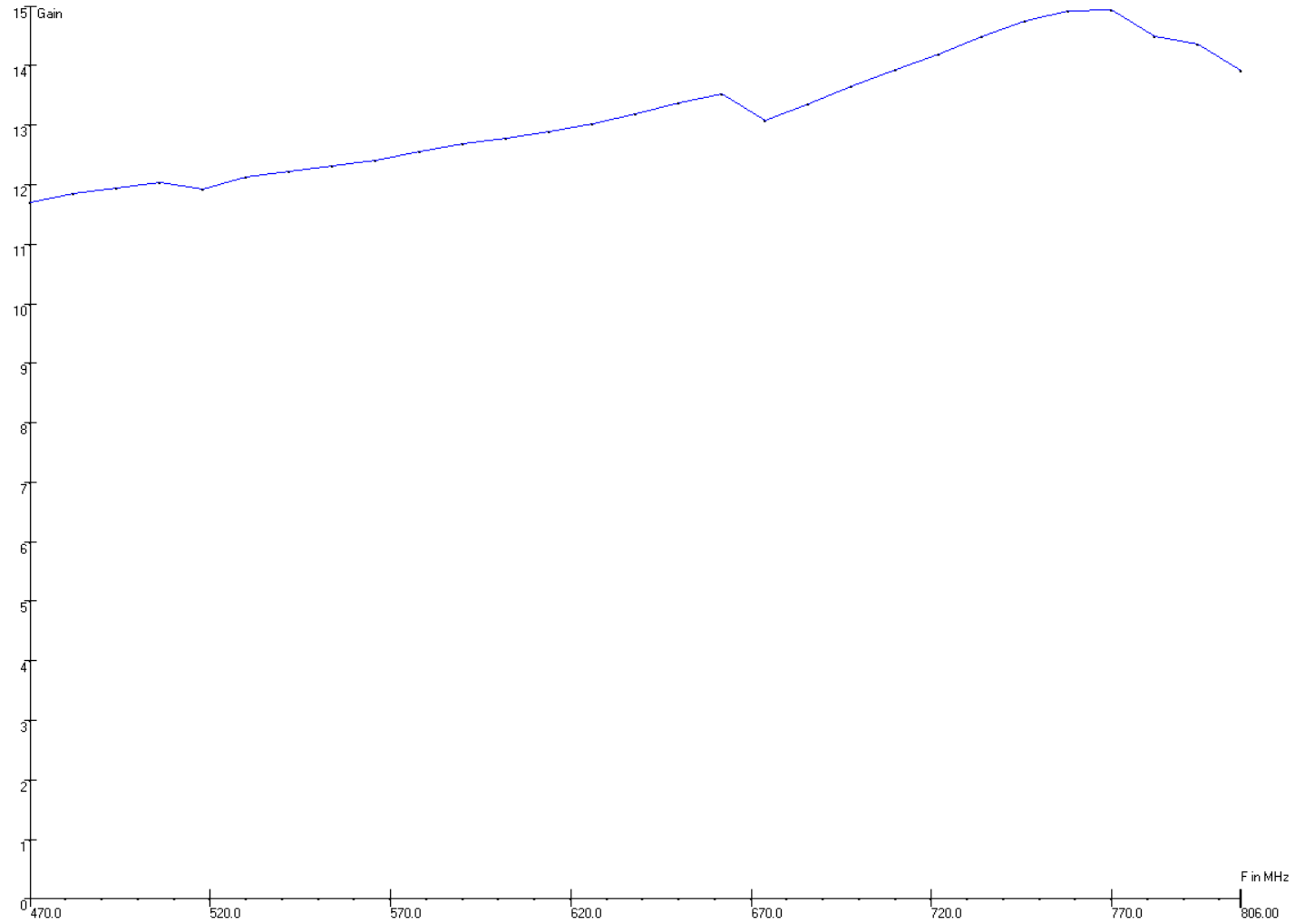



DISA

Antenna F/B

F = 806.000 F/B = 24.88

0 0 STOP

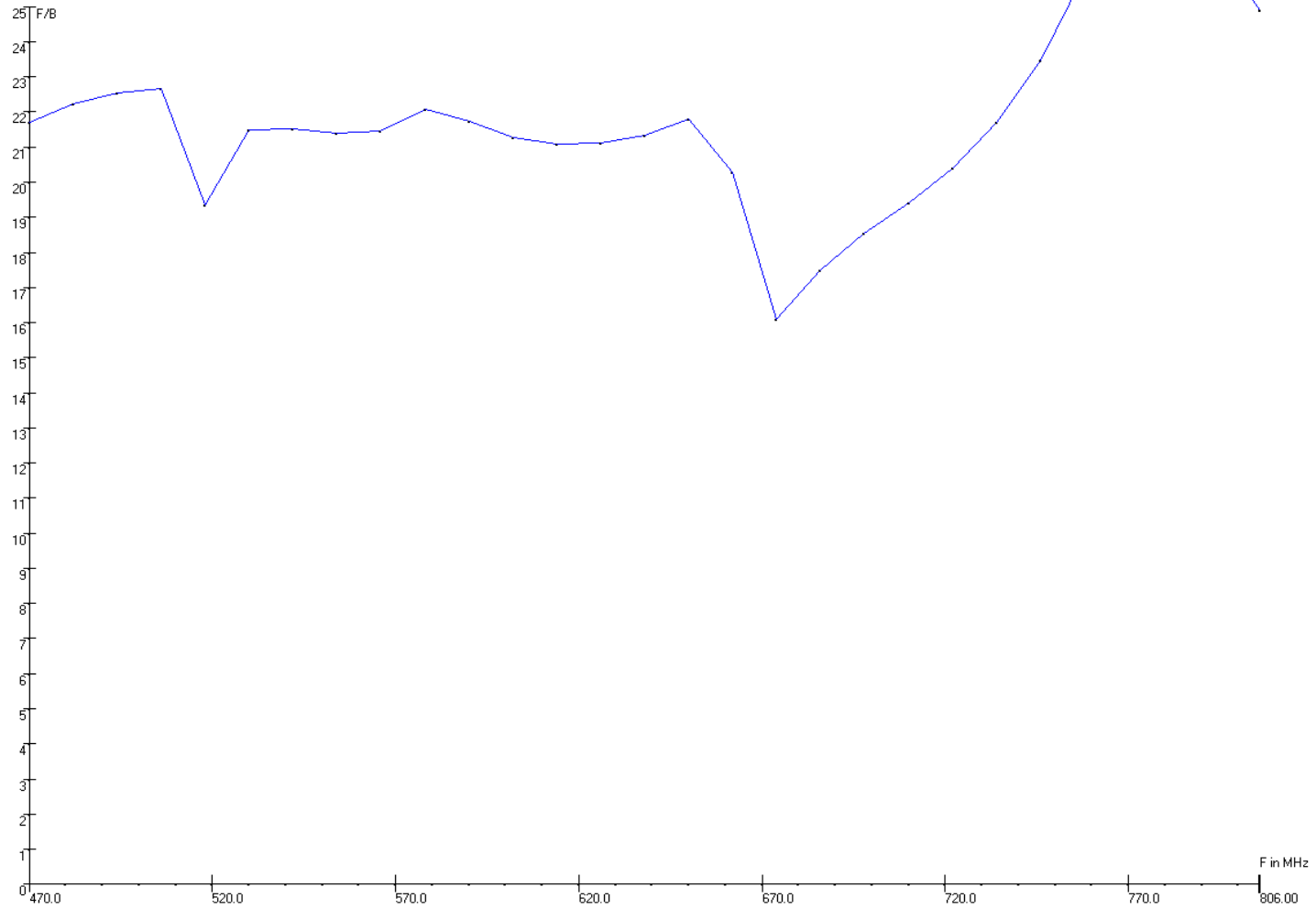



P204.N4W Zenith Total Field

Frequency = 550.000 MHz
Antenna in Free Space
Z1 = 848.58 - j286.68 (3.19)
Max = 12.77 dBi
Lobe at : 180°
Lobe at : 59°
Lobe at : 0° (BW:33°)
Lobe at : 59°

0 dB = 12.77 dBi

